

DOLPHIN

Mechanical Key Cutting Machine
XP-007

User Manual

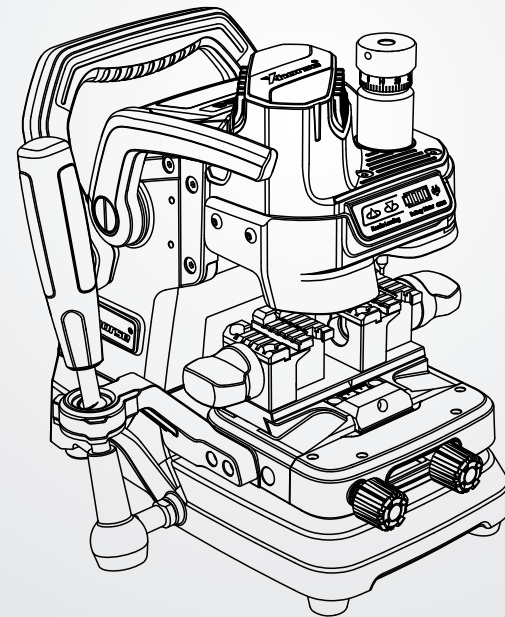



XP-007
Mechanical Key Cutting Machine

TABLE OF CONTENTS

| | | |
|-------|--|----|
| 1 | Safety precautions and warnings | 02 |
| 2 | General information | |
| 2.1 | Machine description | 03 |
| 2.2 | Machine characteristics | 03 |
| 3 | Product packaging checklist | 04 |
| 4 | Overview | |
| 4.1 | Structure diagram | 06 |
| 4.2 | Specification | 07 |
| 4.3 | Main parts with function description | 09 |
| 4.3.1 | Auxiliary handle | 09 |
| 4.3.2 | Main handle | 10 |
| 4.3.3 | Switch | 11 |
| 4.3.4 | Indicative light for height leveling | 11 |
| 4.3.5 | Micro-adjuster | 12 |
| 4.3.6 | Locking knob | 12 |
| 4.3.7 | Supporting arm | 13 |
| 5 | Machine installation and setting | |
| 5.1 | Main handle installation | 14 |
| 5.2 | Probe and cutter installation and uninstallation | 15 |
| 5.3 | Clamp installation and uninstallation | 17 |
| 5.4 | Clamp position calibration | 18 |
| 5.5 | Probe/cutter height adjustment | 20 |
| 5.6 | Fuse replacement and installation | 21 |
| 6 | Operation guide | |
| 6.1 | Key alignment | 22 |
| 6.2 | Key installation guide | 23 |
| 6.2.1 | Sided keys installation | 23 |
| 6.2.2 | External keys and internal keys fixation | 24 |
| 6.2.3 | Arc-types keys fixation | 25 |
| 6.2.4 | Tubular keys fixation | 26 |
| 7 | Maintenance | 27 |
| 8 | Warranty and after-sale description | 27 |

1. Safety precautions and warnings

To avoid injuries to operator or damages to machine, please read through this product user manual carefully before you start and follow the safety notes listed below:

- Always use the machine under safe environment
- Put the machine on a flat and firm platform
- Do not expose machine to the hot sun, or place the machine in a place that is damp, greasy and dusty
- Keep the machine dry and clean and do not put anything on the machine
- Place the machine in a place that is out of children's reach
- Wear protective goggles that are in line with ANSI standard
- Do not get too close to the machine when it is working
- Do not leave the machine unattended when it is working
- Do not use a damaged or loose socket and the power socket what use for charging must has ground cable
- Unplug the machine when it is not in use for a long time or it is under maintenance
- Unplug the machine instantly under unusual circumstance

2. General information

2.1 Machine description

Dear customers, thank you for choosing Dolphin XP-007 mechanical key cutting machine. Dolphin XP-007, with a small volume and light weight, is particularly and carefully designed for locksmiths worldwide. This product user manual provides operating instructions for you to use the machine correctly and safely. To avoid injuries and financial loss, please carefully read this manual through before you start to operate the machine. And we kindly remind you to keep this manual properly for future reference. The images and colors of the machine shown in this user manual are indicative only. If there is inconsistency between the images and actual products, the actual products prevail.









2.2 Machine characteristics







Dolphin XP-007 is a mechanical key cutting machine with the following characteristics:

- Ergonomic design, easy to carry
- Innovative design of multifunctional clamp
- Build-in Lithium battery with a long battery life
- Supporting sided/track/tubular keys
- Multi-switching high speed motor
- Micro-adjuster for dimple keys more accuracy with prepositioning function
- Smart adjustment display and battery level
- Aluminum structure
- Cross rail with high rigidity
- Highly sensitivity operating platform

3. Product packaging checklist

A full package of XP-007 should include accessories listed in the following table. Please have a thorough check when you get this product and contact your distributor if anything in the table is missing.

| Name | Sample picture | Quantity | Description |
|-------------------------|---|----------|---|
| Machine |  | 1 | Key cutting machine |
| Handle |  | 1 | Z axis working handle |
| 2.5mm cutter |  | 1 | Cutting tool ($\varphi 2.5 * \varphi 6 * 40L$) |
| 1.5mm cutter |  | 1 | Cutting tool ($\varphi 1.5 * \varphi 6 * 40L$) |
| Double-sided probe |  | 1 | Probing tool ($\varphi 1.5 * \varphi 2.5 * \varphi 6 * 45L$) |
| Align stopper |  | 2 | Key tip aligning tool |
| 2mm hexagon bar wrench |  | 1 | Probes and cutters installation tool |
| 4 mm hexagon bar wrench |  | 1 | Clamp installation tool |
| Power adapter |  | 1 | Power supply |

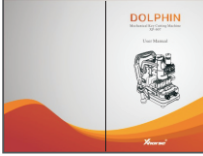
| | | | |
|-----------------------------------|---|---|---|
| Shim |  | 2 | assisting fix the cutting of sided keys |
| 1.5m Power cord of China standard |  | 1 | Connect to power |
| 1.5m Power cord of UK standard |  | 1 | Connect to power |
| 1.5m Power cord of US standard |  | 1 | Connect to power |
| 1.5m Power cord of EU standard |  | 1 | Connect to power |
| Brush |  | 1 | Cleaning tool |
| Product quality certificate |  | 1 | Factory inspection report and packing list |
| User manual |  | 1 | Machine assembly/adjustment/operation instruction |

*Notes:

- Replace cutters regularly to ensure the cutting efficiency.
- Please use a 10A fuse.

4. Overview

4.1 Structure diagram

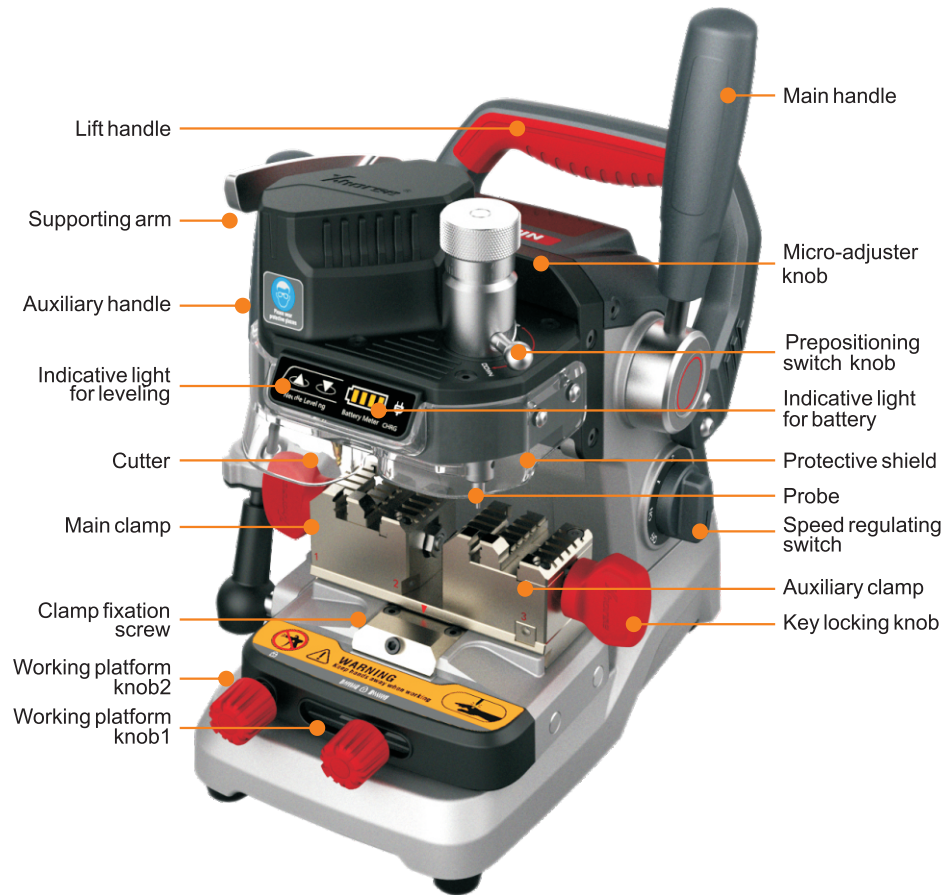

4.2 Specification

| | |
|---------------------------------|---|
| Input voltage | 12-24V |
| Battery capacity | 65.52Wh |
| Power | 120W |
| Main axis rotation speed | Maximum : 13000RPM Gear1 : 8000RPM Gear2 : 10000RPM |
| Motor Torque | Gear1 : 0.12 N.M Gear2 : 0.16 N.M |
| Main axis displacement | 25MM |
| Operating platform displacement | X axis : 36mm Y axis : 50mm |
| Working temperature | 0-50°C |
| Working Humidity | 10-90% |
| Machine dimension | 270*168*355mm |
| Package dimension | 380*340*360mm |
| Net weight | 11.5kg |
| Gross weight | 14kg |

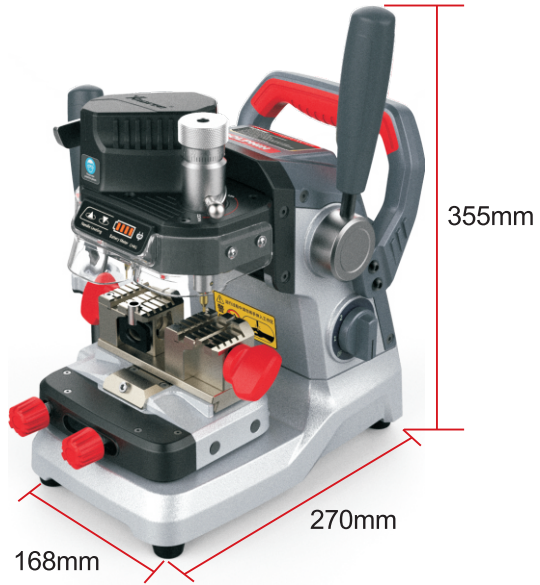

Machine size

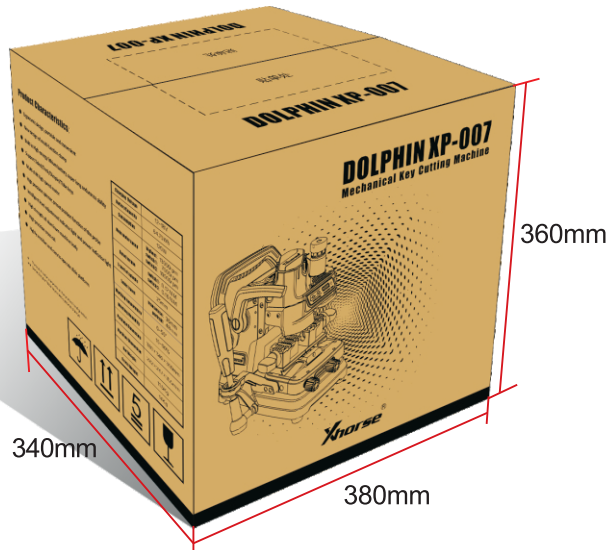

Package size

4.3 Main parts with function description

4.3.1 Auxiliary handle

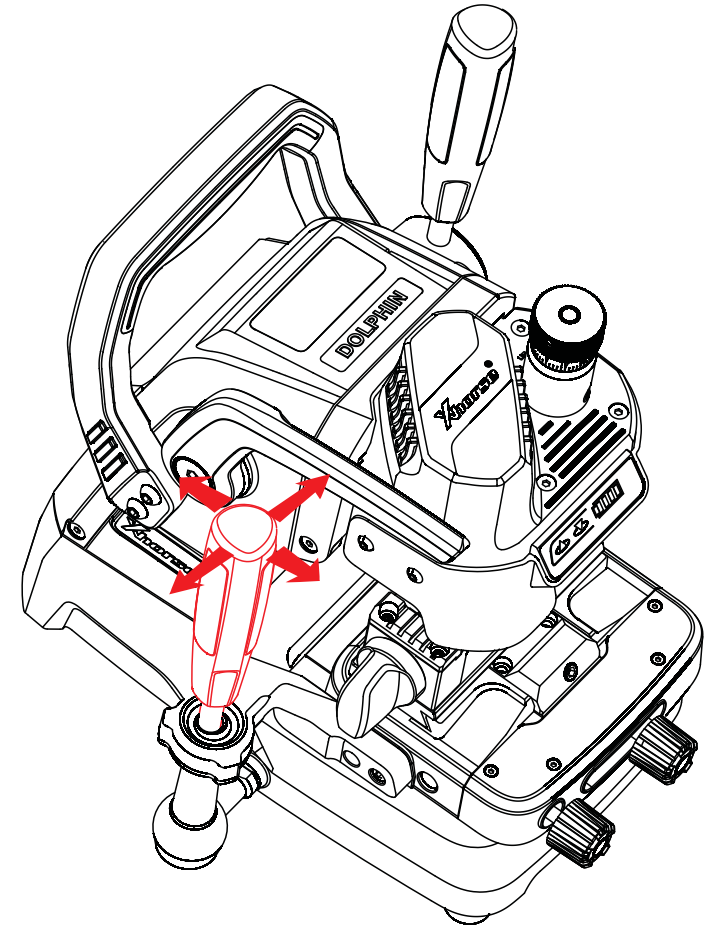

Auxiliary handle is to control the horizontal movement of the cutting platform.

4.3.2 Main handle

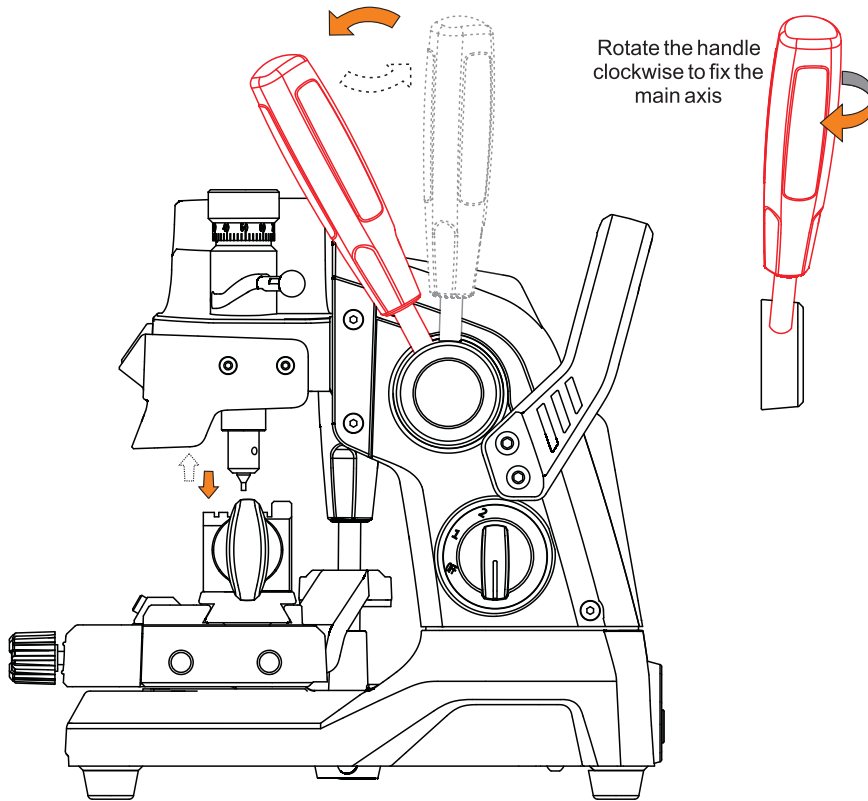

- 1) Move the handle forward or backward to adjust the height of the cutter and probe. The cutter and probe will go back to its initial height when dropping the handle.
- 2) Move the handle to set the height of the cutter and probe and lock them by rotating the handle clockwise.

4.3.3 Switch

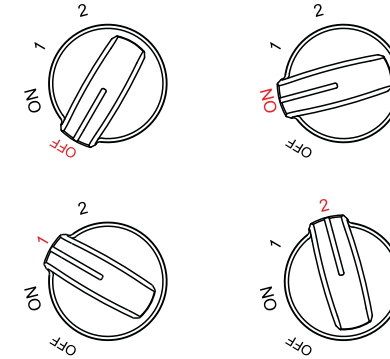

Power switch and speed selection, include OFF, ON, 1, 2 switch position.

- 1) Power is off when switching to 'OFF'.
- 2) Power is on when switching to 'ON', the LED light is on and the machine is on standby.
- 3) The motor is on low speed of 8000 rpm when switching to '1'.
- 4) The motor is on high speed of 10000 rpm when switching to '2'.

4.3.4 Indicative light for height leveling

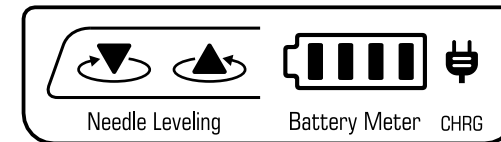

- 1) For adjusting height indicator light.
 Only leftside light on, probe height higher than cutter. Move the micro-adjuster knob clockwise to let probe move down.
 Only rightside light on, cutter height higher than probe. Move the micro-adjuster knob counter-clockwise to let probe move up.
 Only probe and cutter at same height, both light on.
- 2) Battery status
 Full lights on means battery full charge
 Only one green light on, means battery low, please recharge on time.
 Only one red light on, means battery badly low, please recharge asap
- 3) For charging setting
 Charging setting is red means battery low, need to recharge or charging
 Charging setting is green means battery full. You can unplug the power cord.

*Notes:

If the machine without Li-ion battery pack, plug in power cord, the battery indicator is green and the charging indicator lights up in green.

4.3.5 Micro-adjuster

Micro-adjuster includes micro-adjuster knob and prepositioning switch.

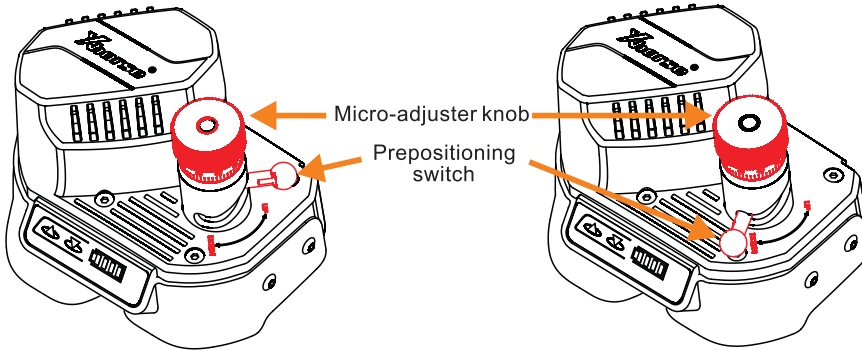

- 1) Micro-adjuster knob allows precise adjustment the height of probe, Turn the knob clockwise to move down the probe and counter-clockwise to move up the probe.
- 2) Prepositioning switch mainly support setting position in advance, mainly for cutting dimple keys more accuracy, When the prepositioning switch is at 'UP', setting position function disabled, prepositioning switch is at 'Down', setting position function enabled, the probe height is lower than the cutter because of inside spring but it can bounce back to a level same to the cutter, when cutting dimple keys, probe will be detected the original key centre point in advance, cutting keys with more accuracy.

4.3.6 Locking knob

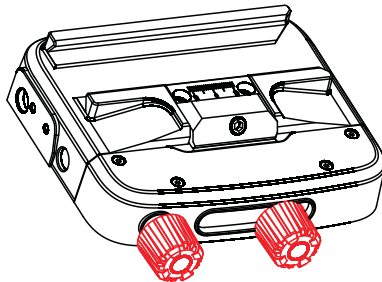

- 1) When the right locking knob is tightened, the working platform from is restricted to move in a smaller distance, it will be easy to control the cutting key width.
- 2) When both locking knobs are tightened, the working platform can only move along Y axis but not along X axis, when cutting dimple keys, in case of the platform horizontal shaking because of the cutting.

*Notes:
Probe micro-adjuster function for prepositioning function only switch at 'UP' position, or may affected on cutting accuracy.

4.3.7 Supporting arm

- 1) The supporting arm with damping effect, it can move up and down.
- 2) When the machine is in use, move the supporting arm to a proper position where you feel good.

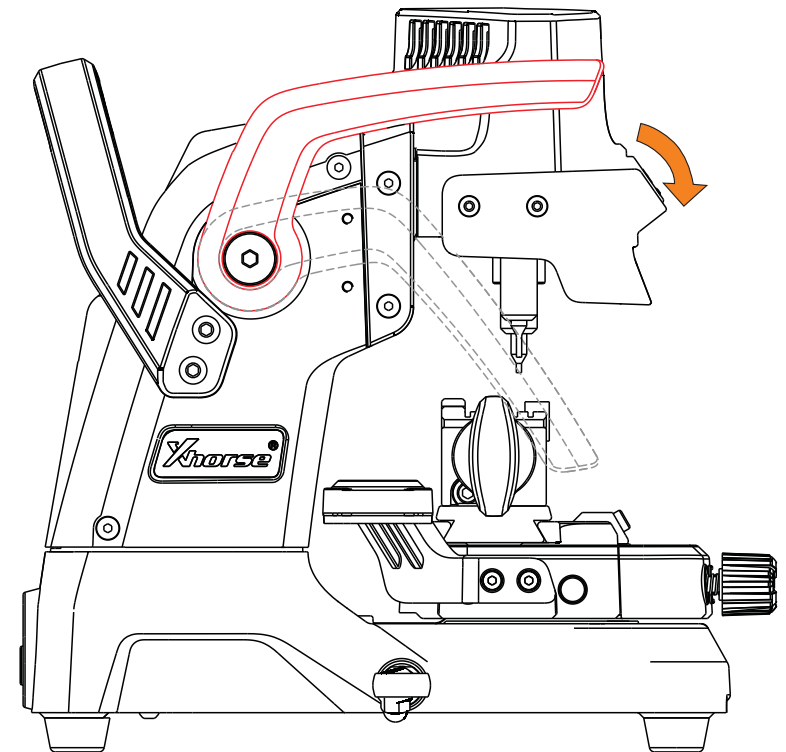

*Notes:
When moving the machine, the supporting arm can be moved forward limited to prevent clamp from shifting.